

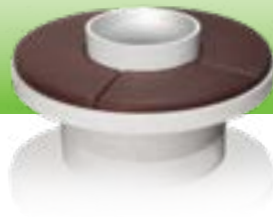

Planter Furniture

Interior & Exterior



introduction

As the UK's leading manufacturer of planters for commercial landscape use, we are delighted to bring together our complimentary range of planter furniture into a new catalogue to help our customers maximise their sales opportunities.

Like the Livinggreen Design planter ranges, our furniture is all manufactured by us, here in the UK, using Fibreglass as the structural material. This ensures the units are both lightweight, and so ideal for roof garden and terraces, but also immensely strong and therefore suitable for the most demanding exterior & interior spaces. Variations of our Fibreglass formulation is used in the manufacture of everything from wind turbines to commercial jet liners so you can have every confidence in specifying our furniture range in any and every situation.

Our vast selection of paint and natural finishes, including replica stone and metals such as our fabulous Corten Steel effect which is literally indistinguishable from the real material, are available for every range. These can be teamed with the most appropriate seating options including a variety of hardwoods, outdoor cushions, indoor cushions or just plain hardwearing fibreglass.

In addition to well-developed standard ranges, we are specialists in Bespoke manufacture and can take a basic idea from sketch to production drawing and finished product within weeks.

contents

Bespoke projects

Terraces 1 & 2

Rhumba

Barrier seating

Curvy xtreme bench

Creative collection



bespoke benches

We have a fully equipped design studio employing professional product designers and graphic artists who can assist you at any point of your bespoke project, including pictorial representation of how the furniture and planters would look in the finished project. Designs can incorporate any combination of planters and seating and can also feature other additions such as lighting, power points, integrated Bluetooth Speaker systems and signage. Our fibreglass can also be specified as fire retardant, ideal for use in enclosed public spaces.

In the example on these pages, the brief was to work with the architect and landscape contractor to create a roof garden featuring long runs of benches and individual seating on stand-alone planters combined with bespoke tree planters singularly and in groups. This was a new corporate HQ in Scotland and the client required sustainable local hardwood for the bench seats. We sourced this as Scottish Larch, perfect for the Client and the situation. This job was designed, manufactured and installed in six weeks from order.



bespoke benches

Here we took a drawing concept and engineered a solution creating sectional planters that would fit together to form sinuous beds making full use of the narrow space. Seating units were formed to exactly match the shapes of the planters allowing a perfect fit and full implementation of the design concept.

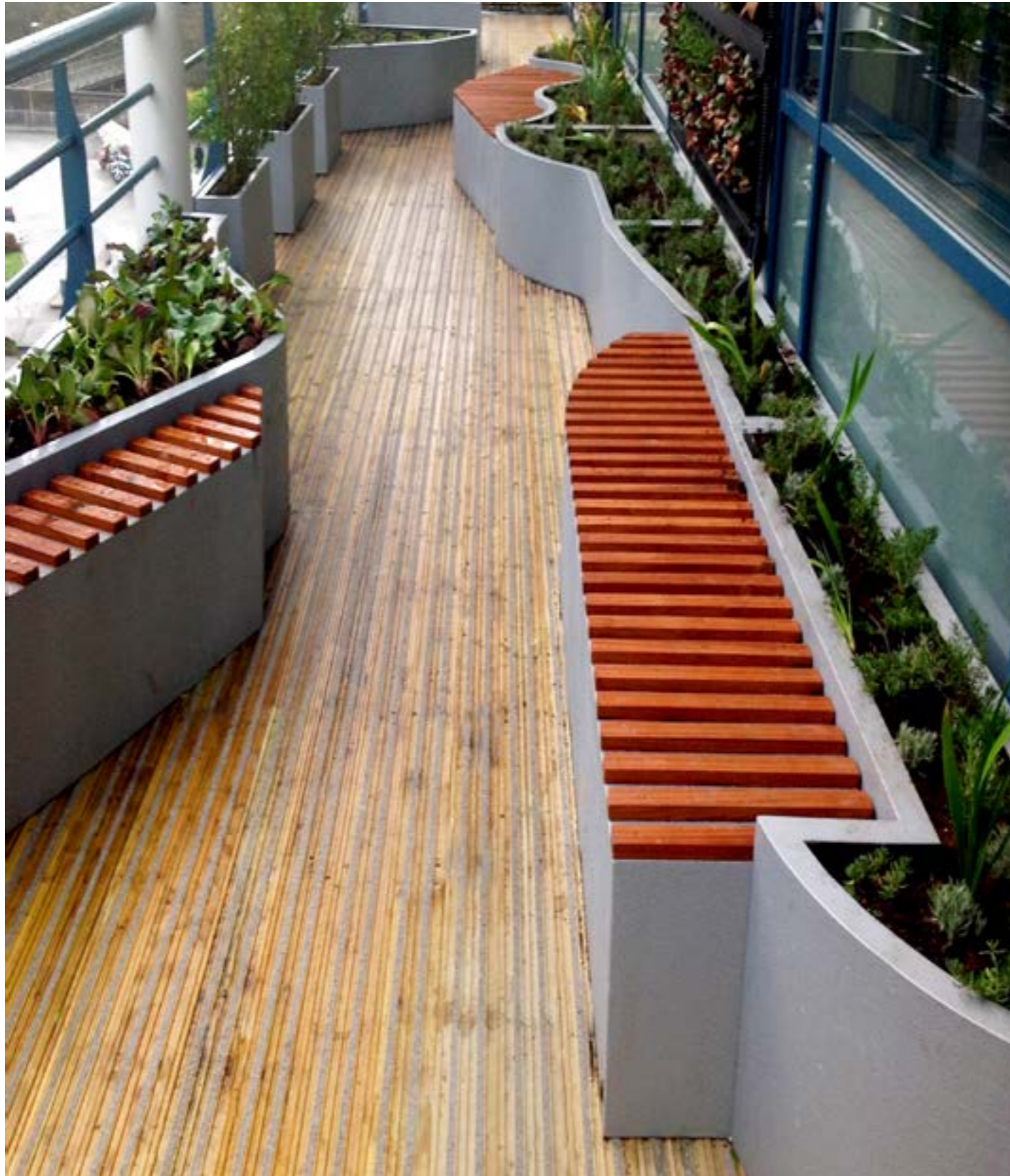

bespoke benches

In this example for a private client, different colours and finishes, including Corten Steel effect, have been combined with alternating curved benches and planters to maximise the usability of a good sized terrace. Working with the Garden Designer, we were able to fully realise his design brief even including integrated lighting and external power points.

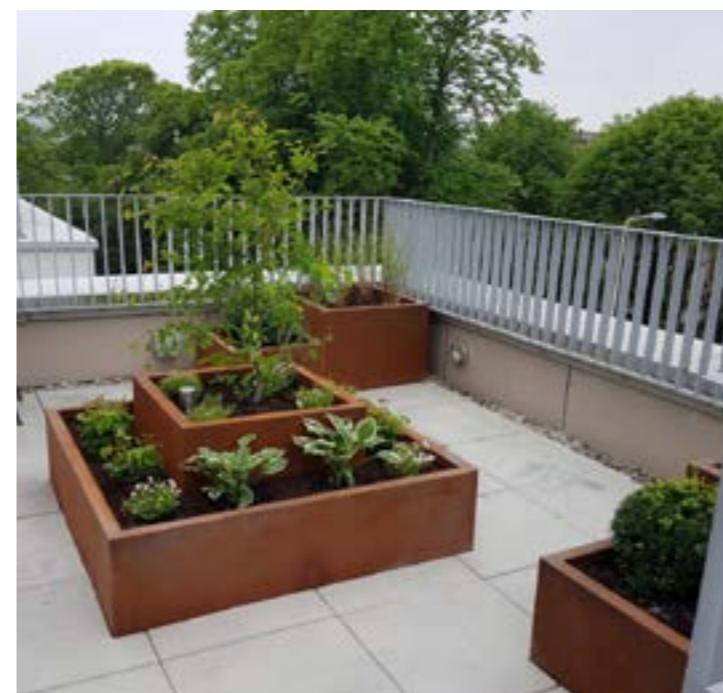

terraces

designer - derek hodgson

Derek Hodgson is a Scottish product designer. After graduating from the Royal College of Art, he established Derek Hodgson Associates in 1980.

His studio has been based in Bath, London, Paris and Edinburgh.

Spanning nearly four decades, the business has worked with UK and International manufacturers, designing products for the office interior, museums, public furniture, transport and signage markets. Clients include, Transport for London, RATP (Paris Transport), British Rail, BAA, National Museums of Scotland, Herman Miller, Kinnarps, Macemain + Amstad and Sign Systems International.

The TERRACES range of planter furniture is a recent collaboration with Livinggreen Design. Introduced in 2013, TERRACES is now expanding to offer a comprehensive modular furniture solution for architects, designers and landscapers working both internally and externally.



terraces 1



terraces 2

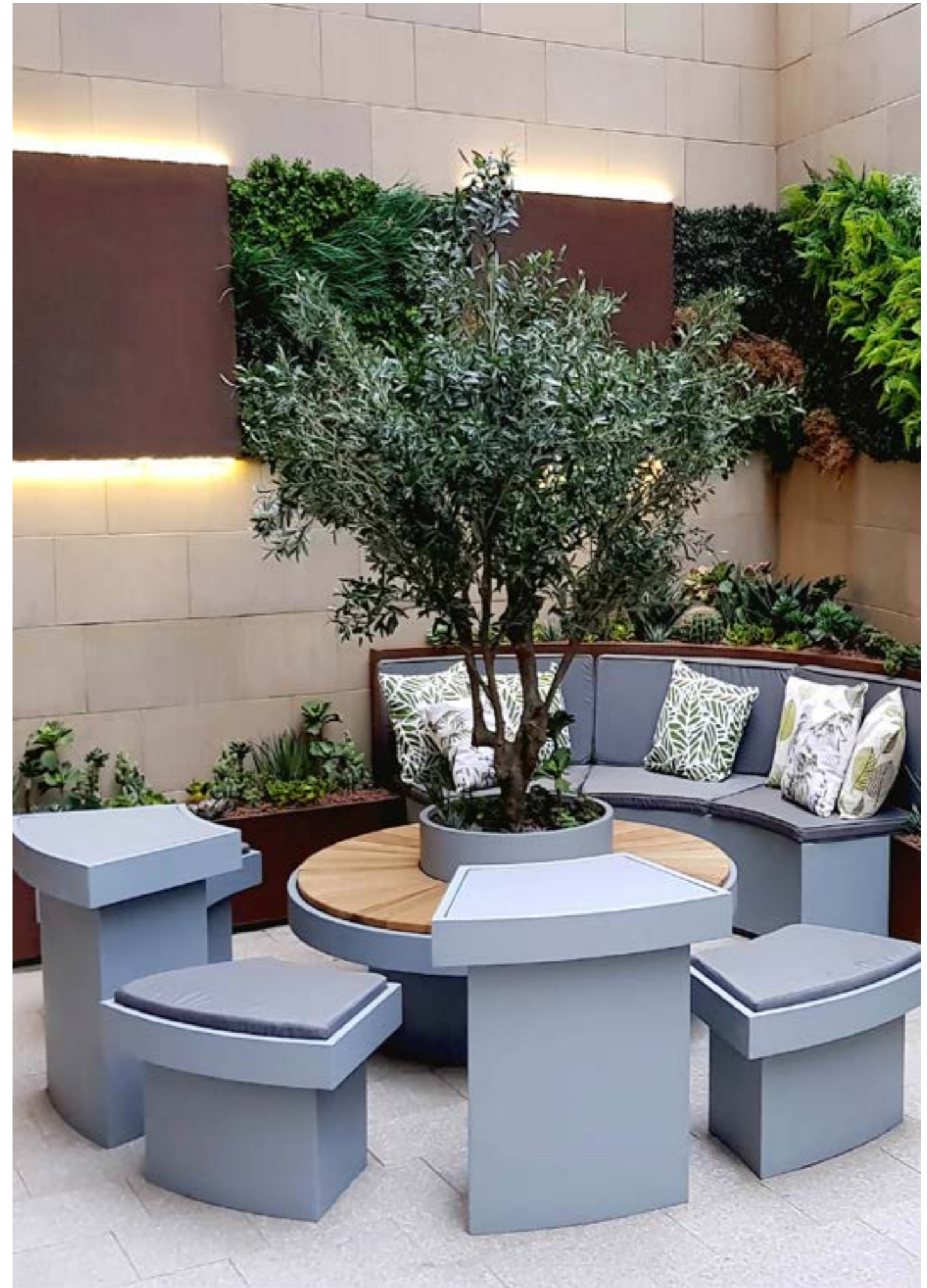

terraces

Terraces is an exciting new collection of planter, seat and table products that form an integrated approach to landscape design. The range offers the flexible tools that, together with informed planting, help define space and movement and inspire the design of high quality environments within a wide range of public and commercial projects.





Any of the Terraces components can be used singularly, they are designed to be combined together to provide integrated layouts featuring planters, seats and tables of varying size and height. The name 'Terraces' refers to its unique capacity for creating tiers of planting, but equally it can be used for simple planting and seating arrangements on the same plane.



terraces 1

36° planter



36TERP01 36TERP02 36TERP03 36TERP04 36TERP05

72° planter



72TERP01 72TERP02 72TERP03



72TERP04 72TERP05

360° planter



360TER900P01



360TER900P02



360TER900P03



360TER900P04



360TER900P05



360TER1200P01



360TER1500P01

Colours + Finishes

BS4800 and RAL Classic: Full colour range in polished gloss, satin, matt and textured matt finishes.

Standard colours: All finishes.

Polished Metallics: All finishes.

Textured Metallics: All finishes.

Polished Pearlescents: All finishes.

Polished Stardust: All finishes.

Natural: All finishes.

Dapple: All finishes.

Premium Stone: All finishes.

See page 63 for all colour and finish options.

terraces 36°

Code



Planter

36TERP01	770 x 500 x 425	550 x 330mm
36TERP02	770 x 500 x 575	550 x 330mm
36TERP03	770 x 500 x 725	550 x 330mm
36TERP04	770 x 500 x 875	550 x 330mm
36TERP05	770 x 500 x 1025	550 x 330mm

terraces 72°

72TERP01	1450 x 640 x 425	1200 x 330mm
72TERP02	1450 x 640 x 575	1200 x 330mm
72TERP03	1450 x 640 x 725	1200 x 330mm
72TERP04	1450 x 640 x 875	1200 x 330mm
72TERP05	1450 x 640 x 1025	1200 x 330mm

terraces 360°

Code



Planter

360TER900P01	900 x 425	600mm
360TER900P02	900 x 575	600mm
360TER900P03	900 x 725	600mm
360TER900P04	900 x 875	600mm
360TER900P05	900 x 1025	600mm
360TER1200P01	1200 x 425	900mm
360TER1500P01	1500 x 1200	1380mm

terraces 1

36° table



72° table

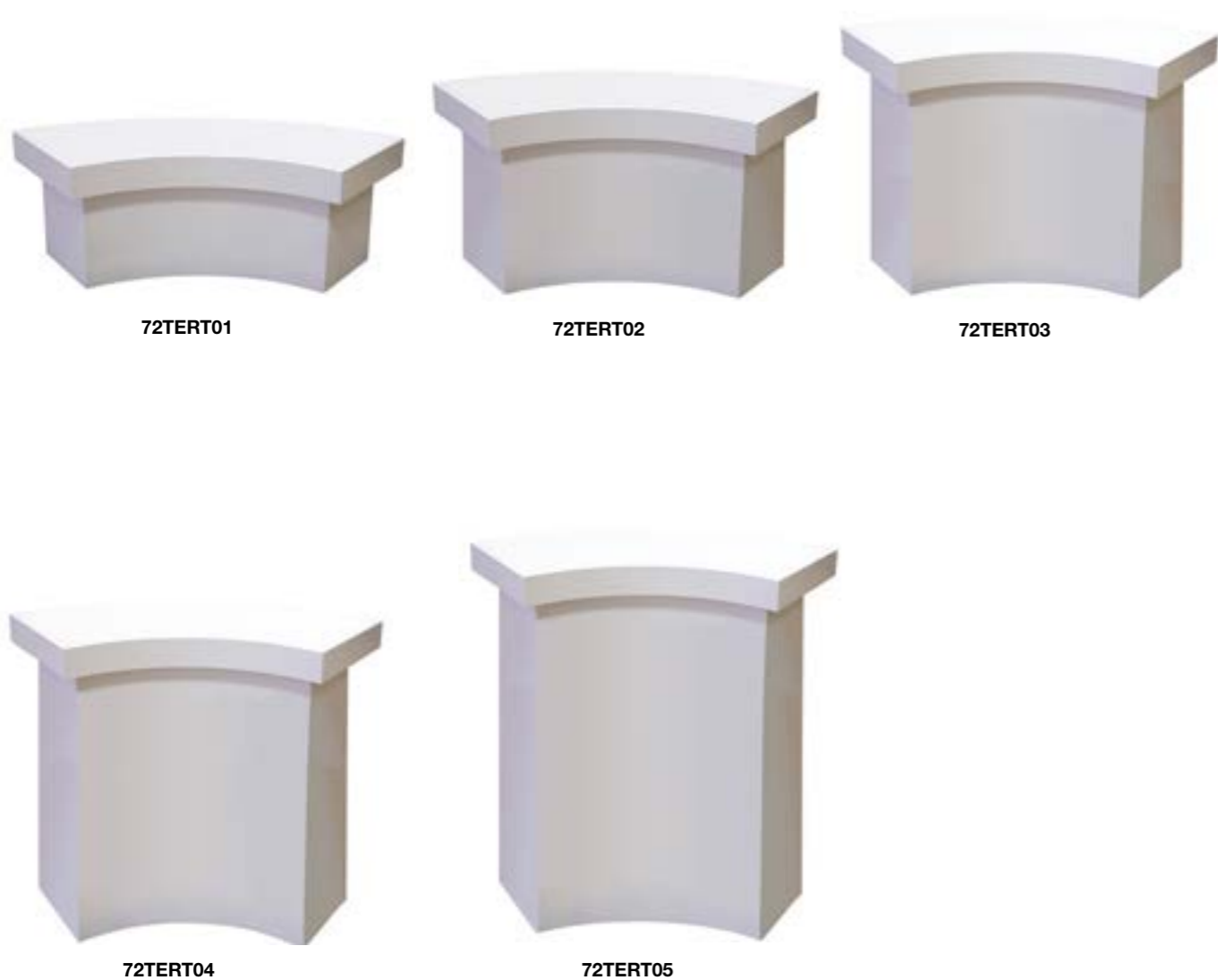

360° table



Colours + Finishes

BS4800 and RAL Classic: Full colour range in polished gloss, satin, matt and textured matt finishes.

Standard colours: All finishes.

Polished Metallics: All finishes.

Textured Metallics: All finishes.

Polished Pearlescents: All finishes.

Polished Stardust: All finishes.



Natural: All finishes.

Dapple: All finishes.

Premium Stone: All finishes.

See page 63 for all colour and finish options.

terraces 36°

Code  

Table

36TERT01 770 x 500 x 425

36TERT02 770 x 500 x 575

36TERT03 770 x 500 x 725

36TERT04 770 x 500 x 875

36TERT05 770 x 500 x 1025

terraces 72°

Table

72TERT01 1450 x 640 x 425

72TERT02 1450 x 640 x 575

72TERT03 1450 x 640 x 725

72TERT04 1450 x 640 x 875

72TERT05 1450 x 640 x 1025

terraces 360°

Code  

Table

360TER900T01 900 x 425

360TER900T02 900 x 575

360TER900T03 900 x 725

360TER900T04 900 x 875

360TER900T05 900 x 1025

360TER1200T01 1200 x 425

360TER1500T01 1500 x 1200

terraces 1

36° seat



36TERS01

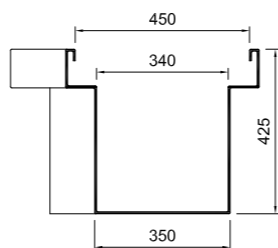
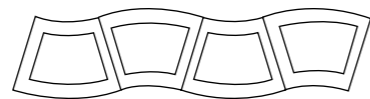

72° seat



72TERS01

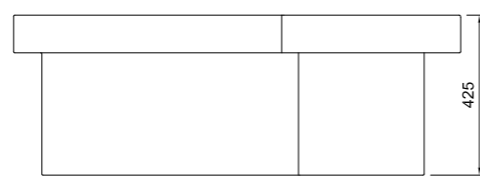
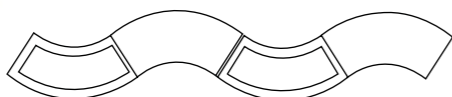

360° seat



360TER1200S01

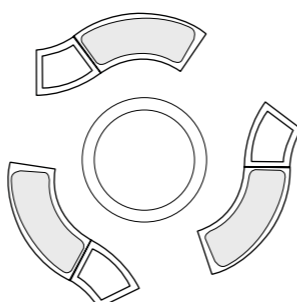
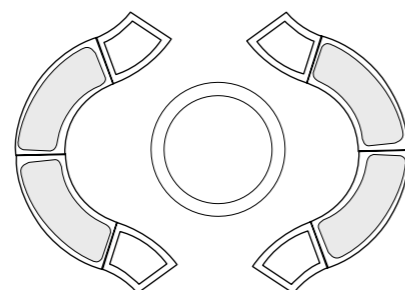

TERRACES 36° planters x 4
TERRACES 72° seats x 4
TERRACES 360° 1200mm seat x 1

TERRACES 36° planters x 3
TERRACES 72° seats x 3
TERRACES 360° 1200mm seat x 1

720° seat

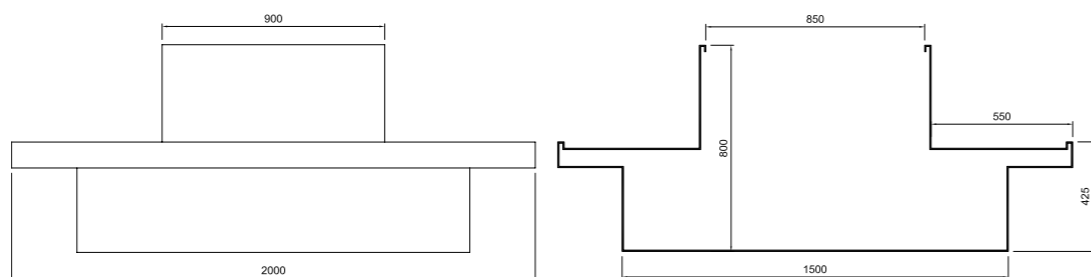
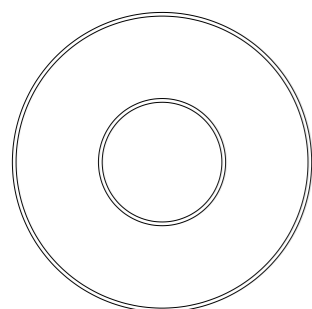

720° seat

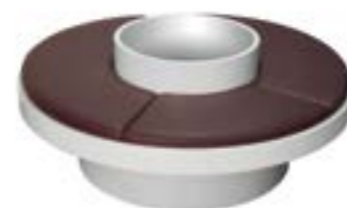

720TER1500S01



720TER1500ST01



720TER1500STT01

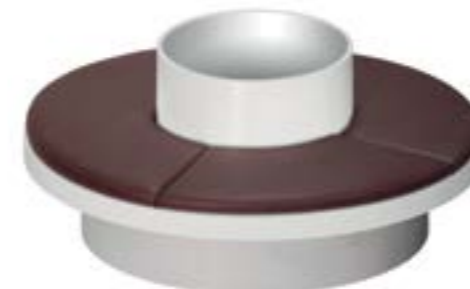

720TER2000S01



720TER2000ST01



720TER2000STT01

Colours + Finishes

BS4800 and RAL Classic: Full colour range in polished gloss, satin, matt and textured matt finishes.

Standard colours: All finishes.

Polished Metallics: All finishes.

Textured Metallics: All finishes.

Polished Pearlescents: All finishes.

Polished Stardust: All finishes.

Natural: All finishes.

Dapple: All finishes.

Premium Stone: All finishes.

See page 63 for all colour and finish options.



terraces 36°

Code

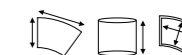

Seat

36TERS01 770 x 500 x 425

terraces 72°

72TERS01 1450 x 640 x 425mm

terraces 360°

Code



Planter

360TER1200S01 1200 x 425mm

terraces 720°

Terraces 720 1500

720TER1500S01 1500 x 425 x 610mm

720TER1500ST01 1500 x 425 x 610mm

720TER1500STT01 1500 x 425 x 610mm



Terraces 720 2000

720TER2000S01 2000 x 425 x 860mm

720TER2000ST01 2000 x 425 x 860mm

720TER2000STT01 2000 x 425 x 860mm

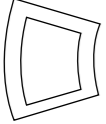

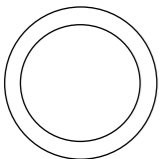

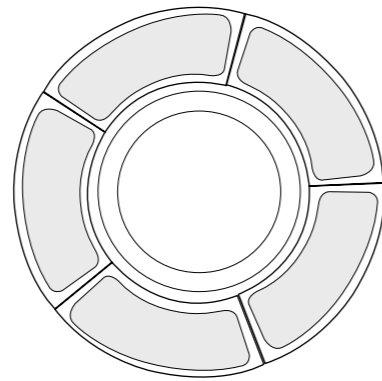
modular options

-  36° Planter
-  72° Planter
-  360° Planter

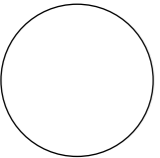

TERRACES 72°
seats x 5

TERRACES 360°
2000 mm planter x 1

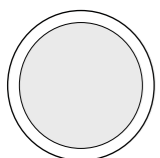
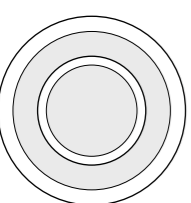
-  36° Table
-  72° Table
-  360° Table
-  36° Seating
-  72° Seating
-  360° Seating
-  720° Seating



terraces 2

The original design of Terraces (Terraces 1) was based on curves and circles to create layouts that can work independently from the surrounding architecture. However, experience has shown that the addition of rectilinear forms can open up more efficient space utilisation, for example, within corners and along walkway locations. This allows Terraces to be used in smaller restricted spaces, but also to create continuous runs of planting/seating when placed together that are suitable for much larger spaces. The new collection also includes curved units that can be used to surround both circular and square columns, as well as large tree planter 'islands' that can be created by placing a number of special modules together.

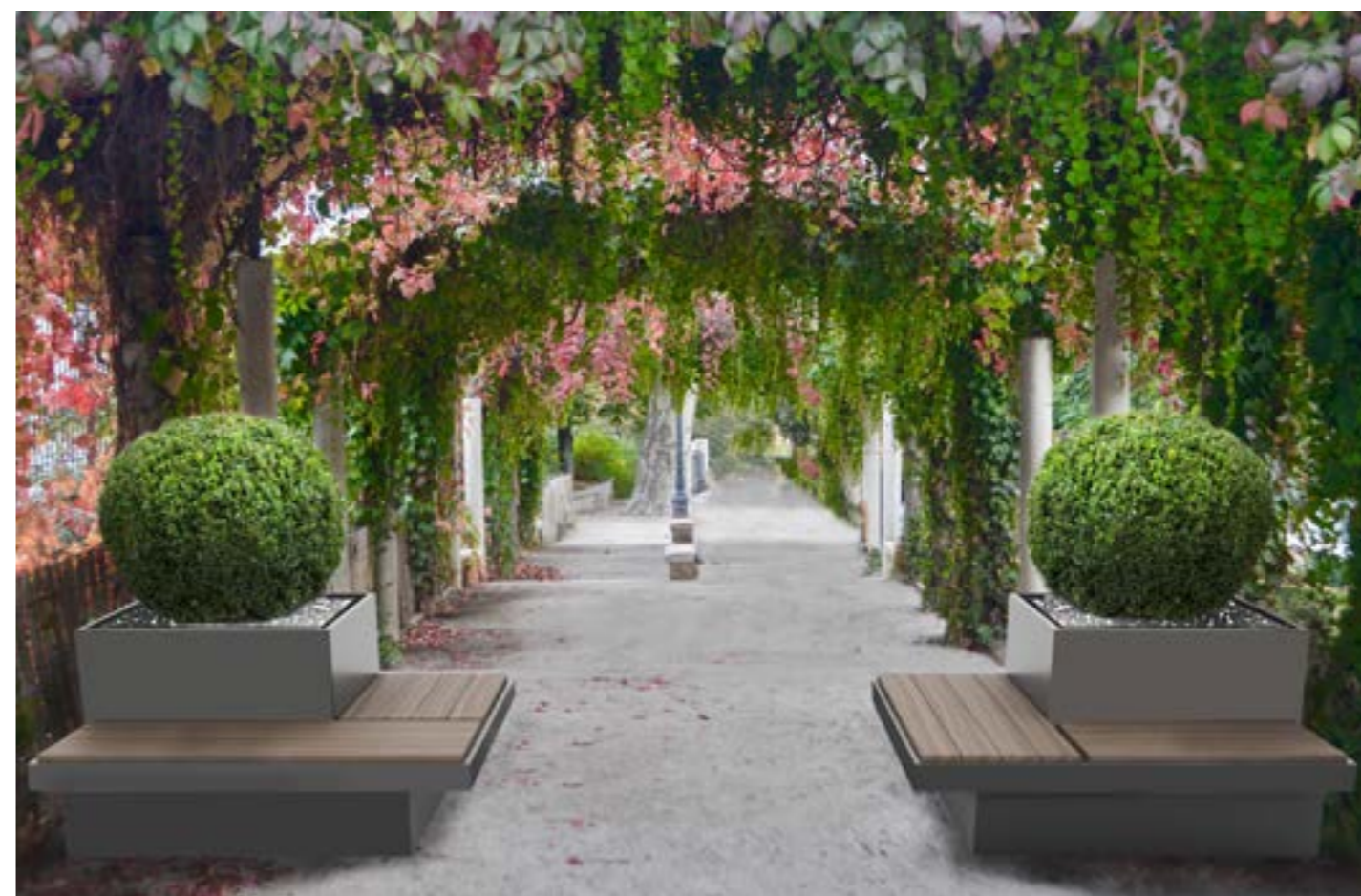

terraces 2

seating



TER2SPA01



TER2SPB02



TER2SPC03



TER2SD01



TER2SE02



TER2SF03



TER2SG04



TER2SH05



TER2SJ06

Colours + Finishes

BS4800 and RAL Classic: Full colour range in polished gloss, satin, matt and textured matt finishes.

Standard colours: All finishes.

Polished Metallics: All finishes.

Textured Metallics: All finishes.

Polished Pearlescents: All finishes.

Polished Stardust: All finishes.

Natural: All finishes.

Dapple: All finishes.

Premium Stone: All finishes.

See page 63 for all colour and finish options.

seat options



Iroko Interior or exterior | Faux leather Interior | Fabric Interior or exterior | Fibreglass Interior or exterior

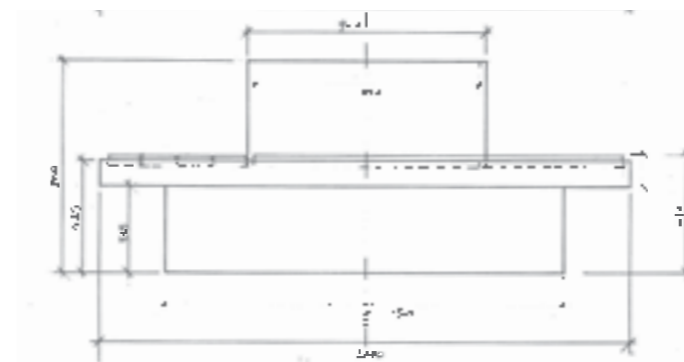
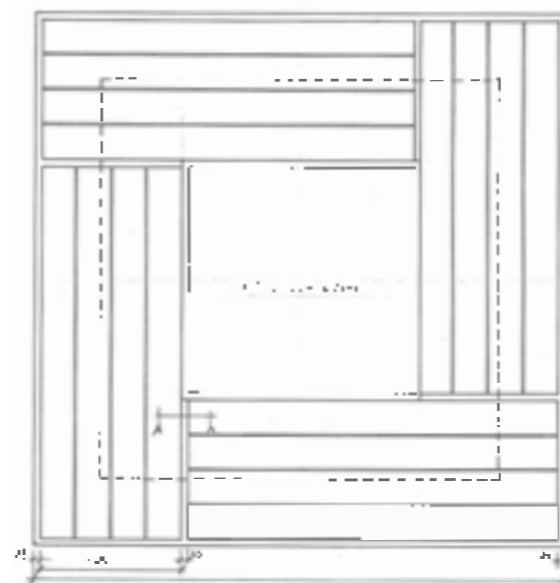

TER2SPA01

Code



TER2SPA01	2000 x 2000 x 450mm	850 x 850mm	800mm
TER2SPB02	2000 x 1450 x 450mm	850 x 850mm	800mm
TER2SPC03	1450 x 1450 x 450mm	850 x 850mm	800mm
TER2SD01	1450 x 500 x 450mm	1400 x 450mm	
TER2SE02	975 x 500 x 450mm	925 x 450mm	
TER2SF03	500 x 500 x 450mm	450 x 450mm	
TER2SG04	1450 x 975 x 450mm	1400 x 450mm	
TER2SH05	1450 x 1450 x 450mm	1400 x 450mm	
TER2SJ06	900 x 900 x 450mm	850 x 850mm	

modular



2 x TER2SPB02



2 x TER2SPC03



4 x TER2SPC03

terraces 2

planter



Colours + Finishes

BS4800 and RAL Classic: Full colour range in polished gloss, satin, matt and textured matt finishes.

Standard colours: All finishes.

Polished Metallics: All finishes.

Textured Metallics: All finishes.

Polished Pearlescents: All finishes.

Polished Stardust: All finishes.

Natural: All finishes.

Dapple: All finishes.

Premium Stone: All finishes.

See page 63 for all colour and finish options.

Code

Code		
TER2PD01	1450 x 500 x 425mm	1400 x 450mm
TER2PE02	975 x 500 x 450mm	925 x 450mm
TER2PF03	500 x 500 x 425mm	450 x 450mm
TER2SPG04 s+planter	1450 x 975 x 425mm	1400 x 450mm
TER2PG04 2xplanter	1450 x 975 x 425mm	1400 x 450mm
TER2PI05	900 x 900 x 725mm	850 x 850mm
TER2PJ06	900 x 900 x 425mm	850 x 850mm
TER2PK07	1000 x 1000/500x 575	850 x 450mm
TER2PL08	1000 x 1000/500x425mm	850 x 450mm
TER2PM09	1000 x 1000/500x 575mm	850 x 450mm
TER2PN10	1000 x 1000/500x425mm	850 x 450mm
TER2PO11	1000 x 500 x 500mm	850 x 450mm
TER2POO12	1000 x 500 x 500mm	850 x 450mm

Planting dimensions lip to lip, smaller at base

terraces 2

table

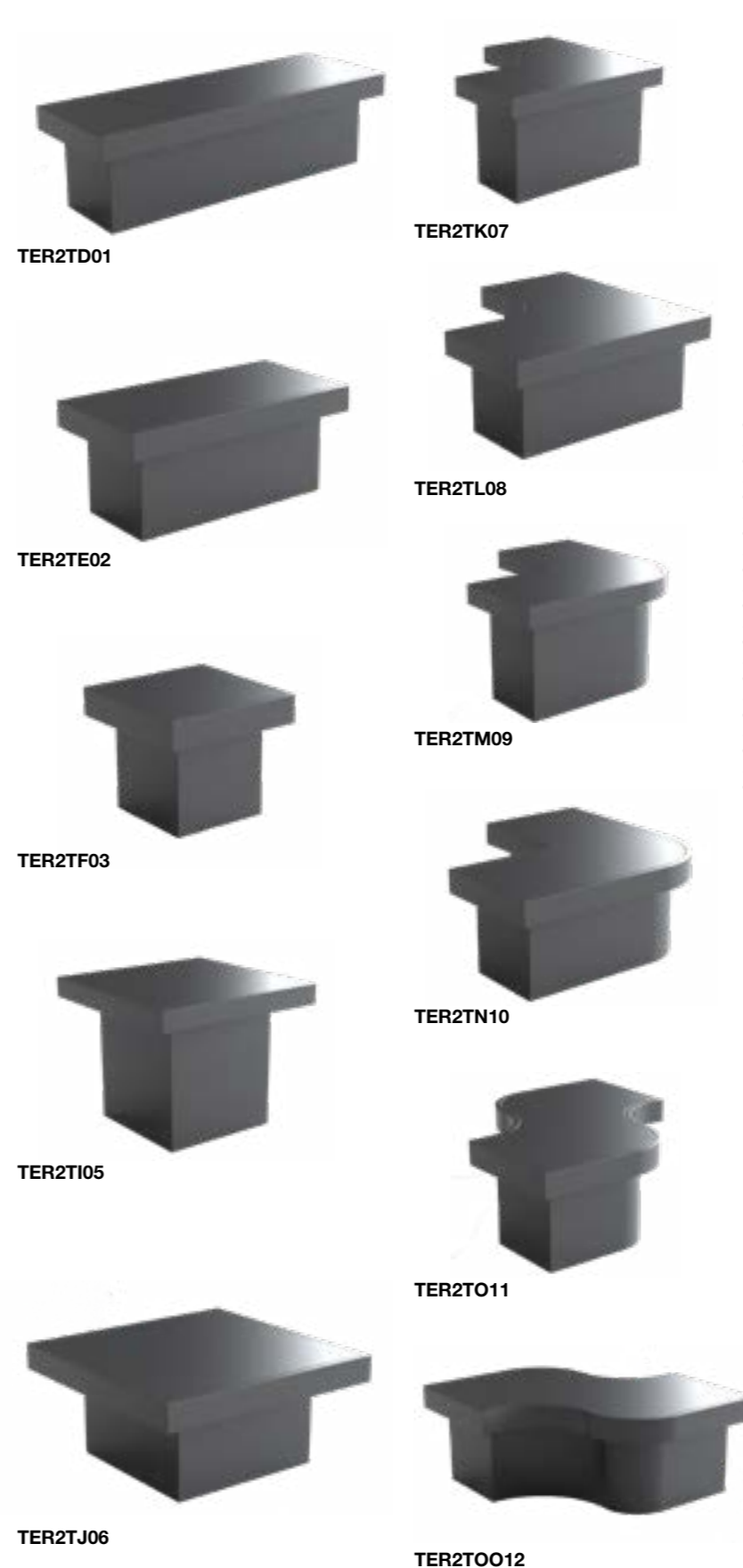

Colours + Finishes

BS4800 and RAL Classic: Full colour range in polished gloss, satin, matt and textured matt finishes.

Standard colours: All finishes.

Polished Metallics: All finishes.

Textured Metallics: All finishes.

Polished Pearlescents: All finishes.

Polished Stardust: All finishes.

Natural: All finishes.

Dapple: All finishes.

Premium Stone: All finishes.

See page 63 for all colour and finish options.

Code

Code	
TER2TD01	1450 x 500 x 425mm
TER2TE02	975 x 500 x 425mm
TER2TF03	500 x 500 x 425mm
TER2TI05	900 x 900 x 725mm
TER2TJ06	900 x 900 x 425mm
TER2TK07	1000 x 1000/500 x 575mm
TER2TL08	1000 x 1000/500 x 425mm
TER2TM09	1000 x 1000/ 500 x 575mm
TER2TN10	1000 x 1000/500 x 425mm
TER2TO11	1000 x 500 x 425mm
TER2TOO12	1000 x 500 x 425mm



2 X TER2SG04 + TER2TD01



3 X TER2SPG04



3 X TER2SPG04



3 X TER2SH05 + 2 X TER2PD01



2 x TER2SPC03 + 2 x TER2SJ06 + 2 x TER2SD01





TER2SD01 + TER2PN10 + TER2PN10 + TER2PN10 + TER2SD01

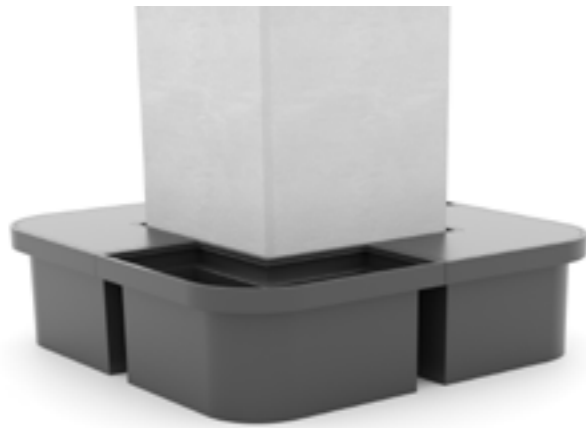

2 x TER2PN10 + 2 x TER2TN10



4 x TER2PN10

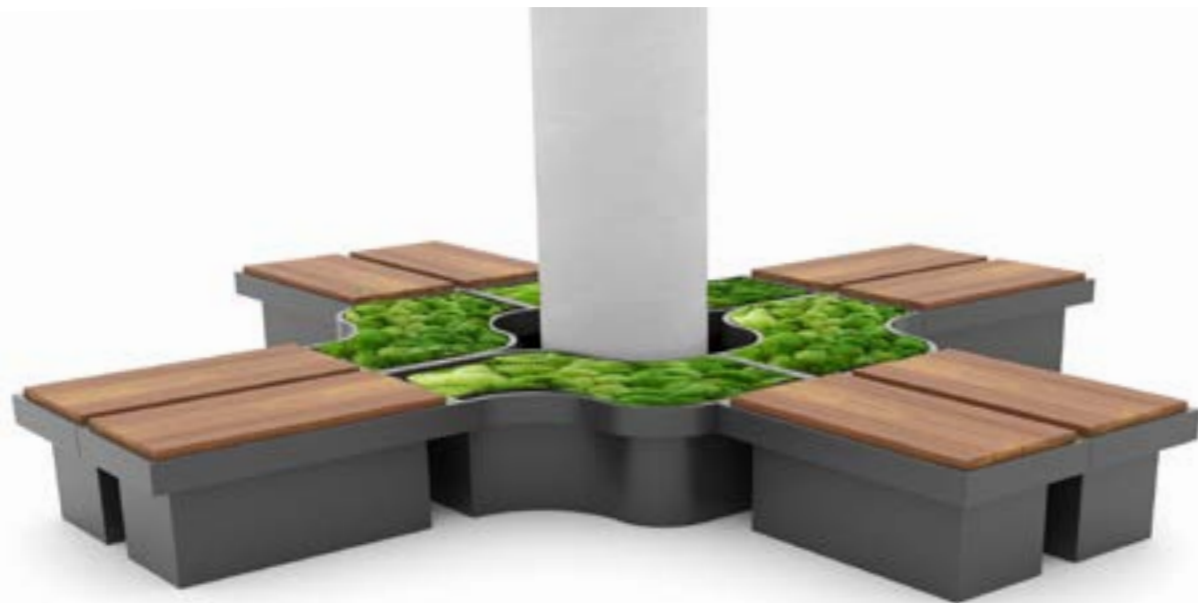

8 x TER2SE02 + 2 x TER2PO11 + 2 x TER2POO12



TER2PO11 + TER2SE02 + TER2POO12



TER2SPB02





2 x TER2SE02 + TER2POO12



2 x TER2SE02 + TER2POO12



1 x TER2SE02 + 2 x TER2PO11

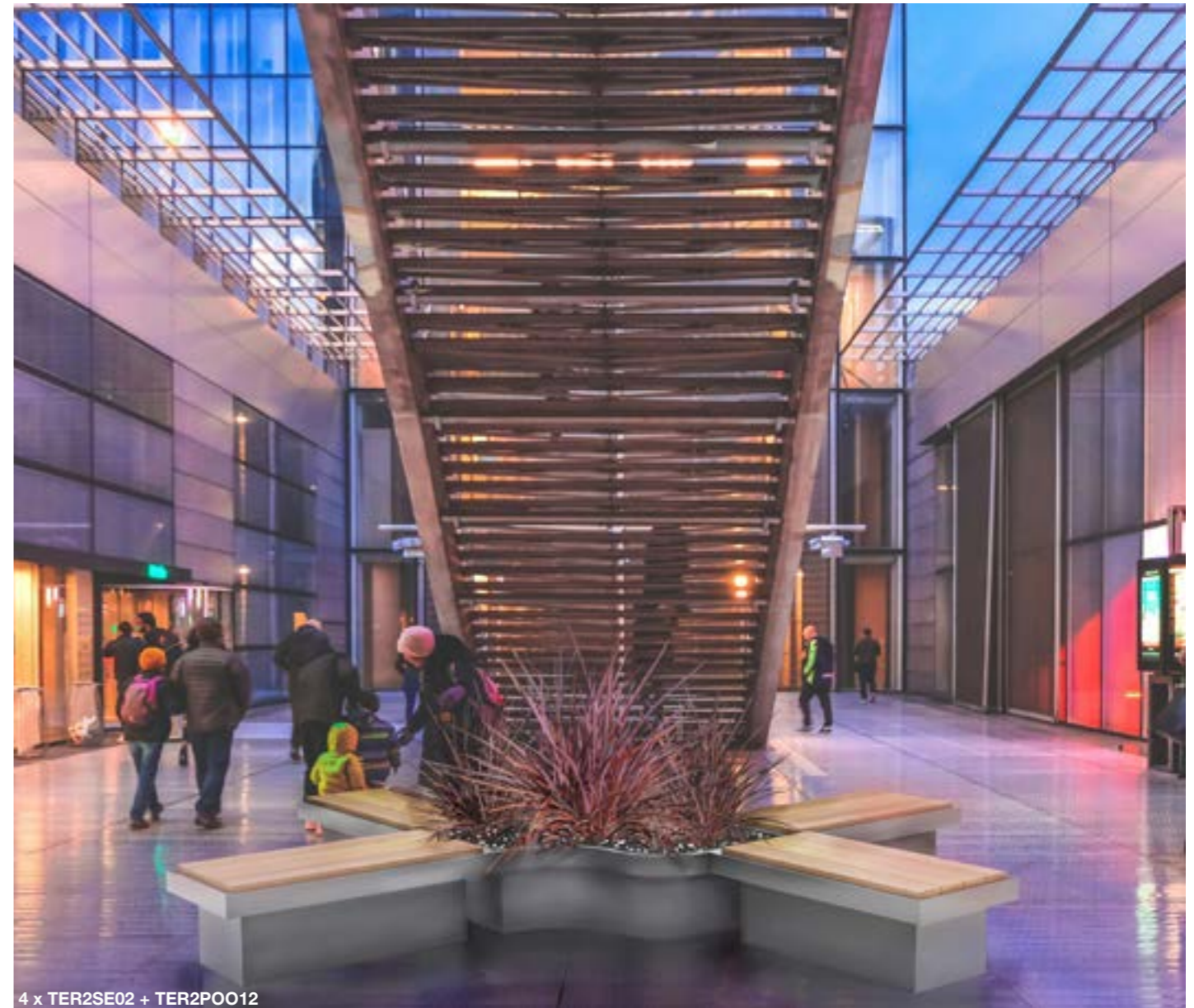

4 x TER2SE02 + TER2POO12



2 x TER2SE02 + TER2POO12

rhumba

Originally conceived for a shopping mall in the south of France, Rhumba is a collection of differently contoured modules that can be put together to form an amazing variety of undulating shapes. Each module can be specified as either a bench or a planter and uniquely, individual units can be bolted together and to the floor, to create enclosed planting beds in the centre. Each unit is on a recessed plinth for ease of adding Led strip lighting if required. Seats can be specified in iroko, indoor or exterior grade fabric cushions or as weatherproof hardwearing fibreglass.



rhumba planter

Colours + Finishes

BS4800 and RAL Classic: Full colour range in polished gloss, satin, matt and textured matt finishes.

Standard colours: All finishes.

Polished Metallics: All finishes.

Textured Metallics: All finishes.

Polished Pearlescents: All finishes.

Polished Stardust: All finishes.

Natural: All finishes.

Dapple: All finishes.

Premium Stone: All finishes.

See page 63 for all colour and finish options.

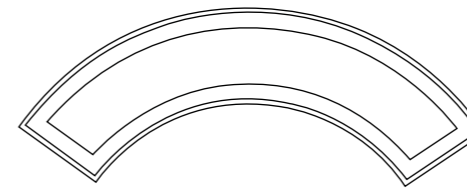

RHUMP01



RHUMP02

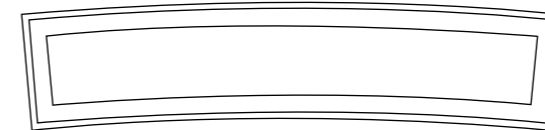

RHUMP03



RHUMP04/05/06

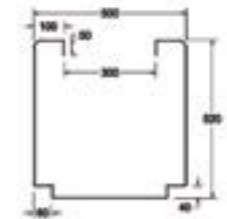

Code

Code	Dimensions (mm)	Width (mm)
RHUMP01	2439/1620 x 500 x 520	300mm wide
RHUMP02	2241/1765 x 500 x 520	300mm wide
RHUMP03	2367/2275 x 500 x 520	300mm wide
RHUMP04	1000 x 500 x 520	300mm wide
RHUMP05	1200 x 500 x 520	300mm wide
RHUMP06	1500 x 500 x 520	300mm wide



rhumba bench

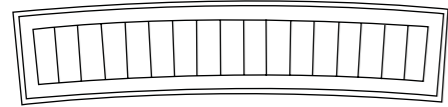

RHUMB01

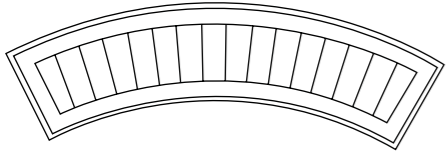

RHUMB02

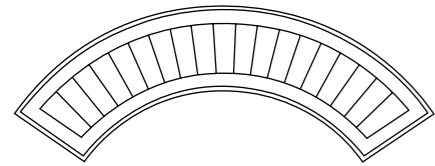

RHUMB03



RHUMB04/05/06

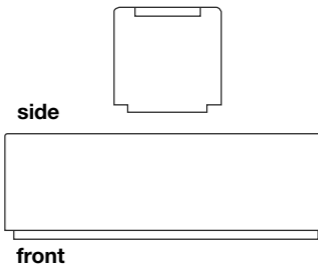

Colours + Finishes

BS4800 and RAL Classic: Full colour range in polished gloss, satin, matt and textured matt finishes.

Standard colours: All finishes.

Polished Metallics: All finishes.

Textured Metallics: All finishes.

Polished Pearlescents: All finishes.

Polished Stardust: All finishes.

Natural: All finishes.

Dapple: All finishes.

Premium Stone: All finishes.

See page 63 for all colour and finish options.

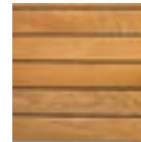

Iroko
Interior or exterior

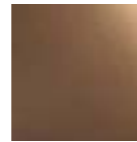

Fibreglass
Interior or exterior

Code

Code	Dimensions
RHUMB01	2439/1620 x 500 x 520
RHUMB02	2241/1765 x 500 x 520
RHUMB03	2367/2275 x 500 x 520
RHUMB04	1000 x 500 x 520
RHUMB05	1200 x 500 x 520
RHUMB06	1500 x 500 x 520

seating options

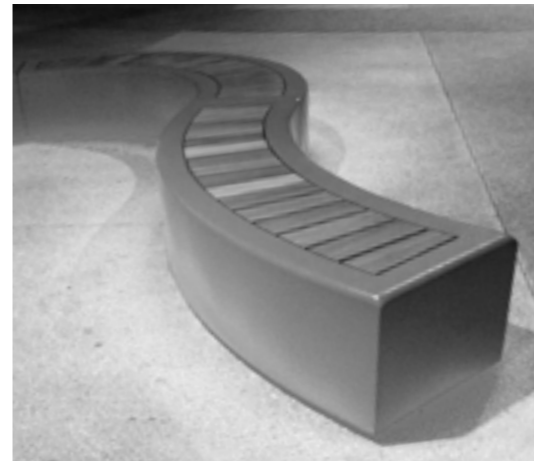
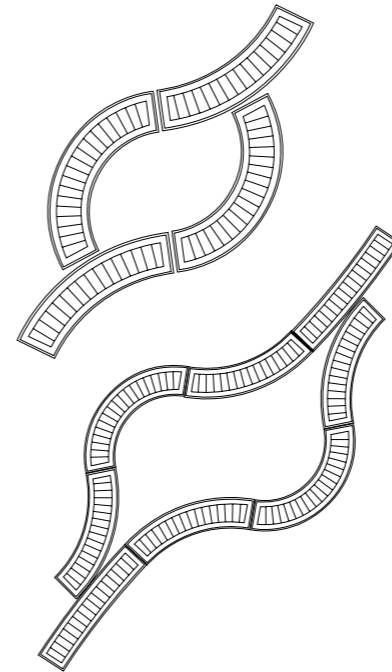

barrier seating

A great compliment to our very popular Barrier and Cube ranges. These stand-alone planter seats are the perfect cost effective solution for many commercial and private landscape schemes. Different widths and lengths available seating from 1-10 seats.



FLOAT WITH OLIVE TREEKIT



Colours + Finishes

BS4800 and RAL Classic: Full colour range in polished gloss, satin, matt and textured matt finishes.
Standard colours: All finishes.
Polished Metallics: All finishes.
Textured Metallics: All finishes.
Polished Pearlescents: All finishes.
Polished Stardust: All finishes.
Natural: All finishes.
Dapple: All finishes.
Premium Stone: All finishes.
 See page 63 for all colour and finish options.

barrier seating classic

Code				
REC BEN 01	1 person	1000 x 400 x 450		400x240mm
REC BEN 02	2 people	1200 x 400 x 450		400x240mm
REC BEN 03	4 people	1500 x 800 x 450		500x600mm
REC BEN 04	4 people	2000 x 800 x 450		1000x600mm
REC BENEH 04 high		2000 x 800 x 450/900		960x560mm
REC BEN 05	10 people	2400 x 1400 x 450		1400x600mm
REC BENEH 05 high		2400 x 1400 x 450/900		1360x560mm

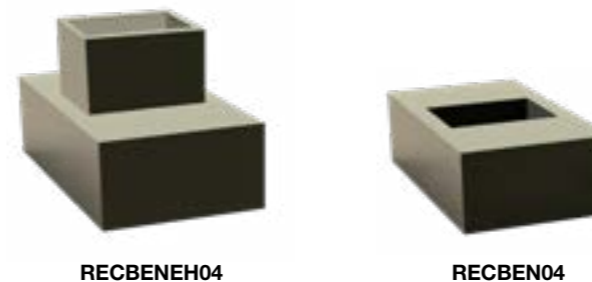

barrier seating float

Code				
FLOA04S*		1200 x 1200 x 450		600 x 600mm

*FLOA04S is designed to be used as a seat planter. Please note the standard float series are not sufficiently strengthened to be used as seating planters.



barrier seating lux with iroko seating

Code				
BARRLUXS01	1 person	400 x 400 x 450		
BARRLUXS02	2 people	1000 x 400 x 450		
BARRLUXS03	3 people	1200 x 400 x 450		

Bespoke sizes available to order, please ask for a quotation

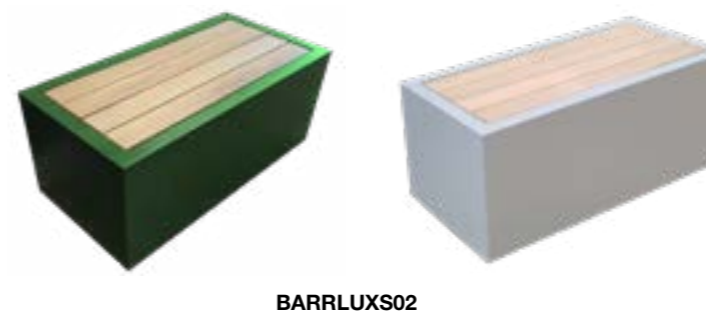

barrier seating classic + float

In their CLASSIC form with solid fibreglass seats, between 1 and 10 people can be accommodated, with the larger units able to accept specimen trees.

Adding to this range, the FLOAT seat, offers a floating effect, square sided option.



barrier seating lux

The new LUX seating modules provide a very cost efficient solution to bespoke seating arrangements.

As well as the basic sizes shown, LUX bespoke modules can be created to allow an exact fit in any space and teamed with barriers to provide backrests if required.

Curved units are also possible and all can be made to incorporate lighting, power points and loudspeakers.

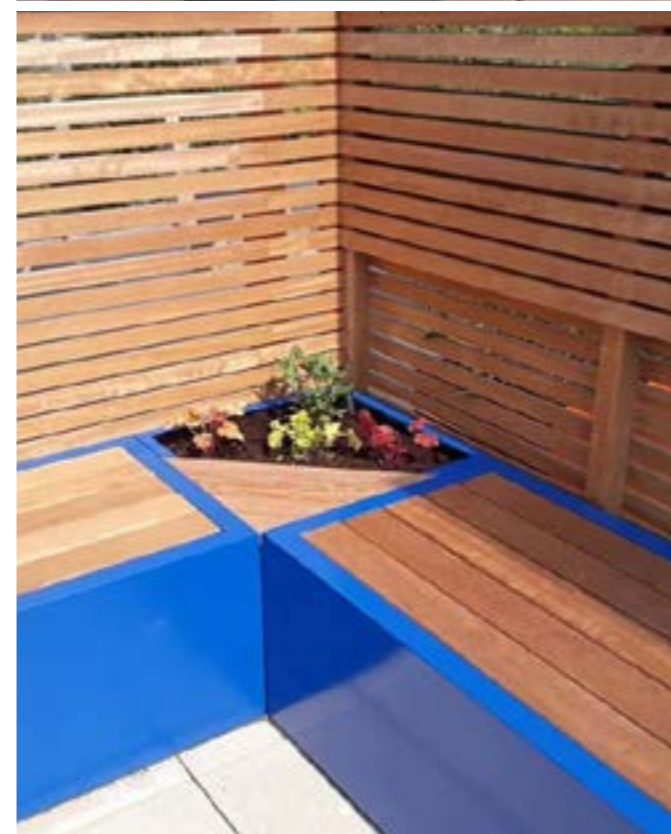

curvy xtreme

Offered as a design led alternative to the Barrier seating range, Curvy Xtreme has the same hardwearing fibreglass seats and recessed planting space integrated into the end of each bench if required. Four lengths are available each with 3 differently shaped and sized planting areas. Taller barrier units can also be created to fit perfectly behind the benches to offer space division and multilevel planting. A huge range of complimentary planters are also available (Curvy range). Part of a larger range in the main brochure.



PLANTER OPTIONS



OPTION A



300mm

OPTION B



300x339mm

OPTION C



400x339mm

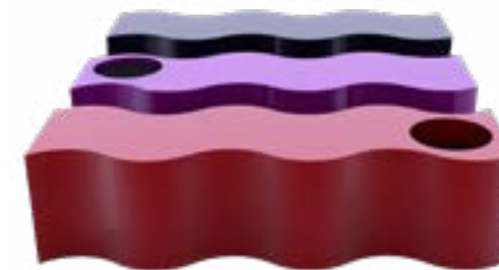

Colours + Finishes

BS4800 and RAL Classic: Full colour range in polished gloss, satin, matt and textured matt finishes.
Standard colours: All finishes.
Polished Metallics: All finishes.
Textured Metallics: All finishes.
Polished Pearlescents: All finishes.
Polished Stardust: All finishes.
Natural: All finishes.
Dapple: All finishes.
Premium Stone: All finishes.
 See page 63 for all colour and finish options.

Code

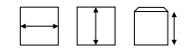

seating bench	
CURSXBH1	900 x 450 x 450mm
CURSXBH2	1200 x 450 x 450mm
CURSXBH3	1500 x 450 x 450mm
CURSXBH4	1800 x 450 x 450mm
planter bench	
CURSXBHP1A	900 x 450 x 450mm
CURSXBHP1B	900 x 450 x 450mm
CURSXBHP2A	1200 x 450 x 450mm
CURSXBHP2B	1200 x 450 x 450mm
CURSXBHP3A	1500 x 450 x 450mm
CURSXBHP3B	1500 x 450 x 450mm
CURSXBHP3C	1500 x 450 x 450mm
CURSXBHP4A	1800 x 450 x 450mm
CURSXBHP4B	1800 x 450 x 450mm
CURSXBHP4C	1800 x 450 x 450mm

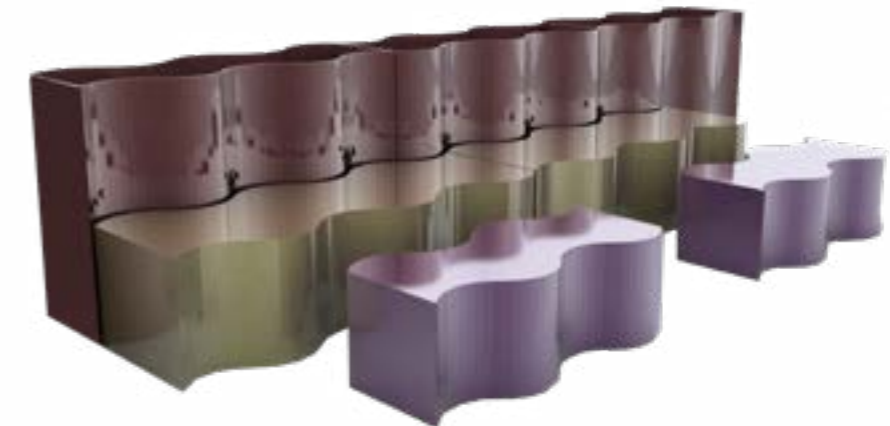

creative collection

Across the main Livinggreen Design Planter range, many feature stools or benches as an integral part of that product's design. These are collected together here and offer a great diversity of form and function. From the Snapback seats originally designed for RHS Chelsea to the ultra-modern Totem stools and wayfinding Arrow benches, there is truly something for every location and situation.

Look up the full range for each one in the main Livinggreen Design Catalogue for more inspiration in planning your projects.

contents

Arrow bench

Blob seating

Curvy s bench

Easter Island cube bench+planter

Heart stool+bench+table+planter

Pets table+stool+bench+planter+shelf

Pentik stool+bench+table

Polybar bench+planter+pond

Snapback bench+planter

Totem stool+table



designer - francesca attala

22 DEGRES was founded in 2007 by Francesca ATTALA, an English trained architect, living and working in France since 1991.

She has a wide ranging project experience in architecture, interior, vertical and urban landscaping and product design.

Her creative work is represented by her company Attala Creations, the products she represents and sources by 22 DEGRES.

She is a design consultant with Livinggreen Design since 2009 working on product design, photography, graphic design and marketing material.

Bilingual (French and English), with a degree in Architecture from Manchester Polytechnic and a diploma in Architecture from EASA Architecture school in Marseilles.



Collections designed in collaboration with Livinggreen Design since 2009 :
Arrow, Easter Island, Heart, Pentik, Polybar, Pets, Totem, UNC, Wave and Alphabet.

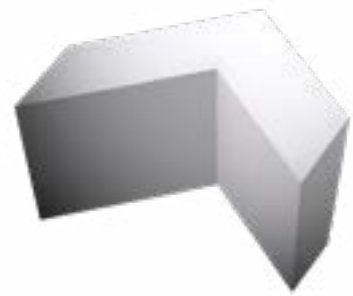

arrow



easter island cube

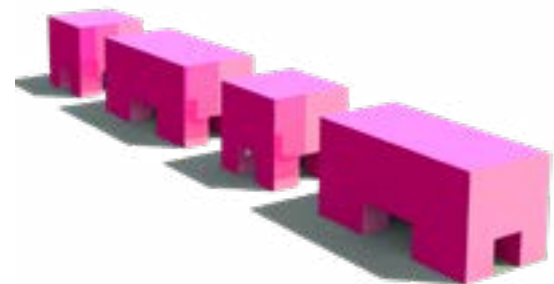

pets



pentik



polybar



heart



totem

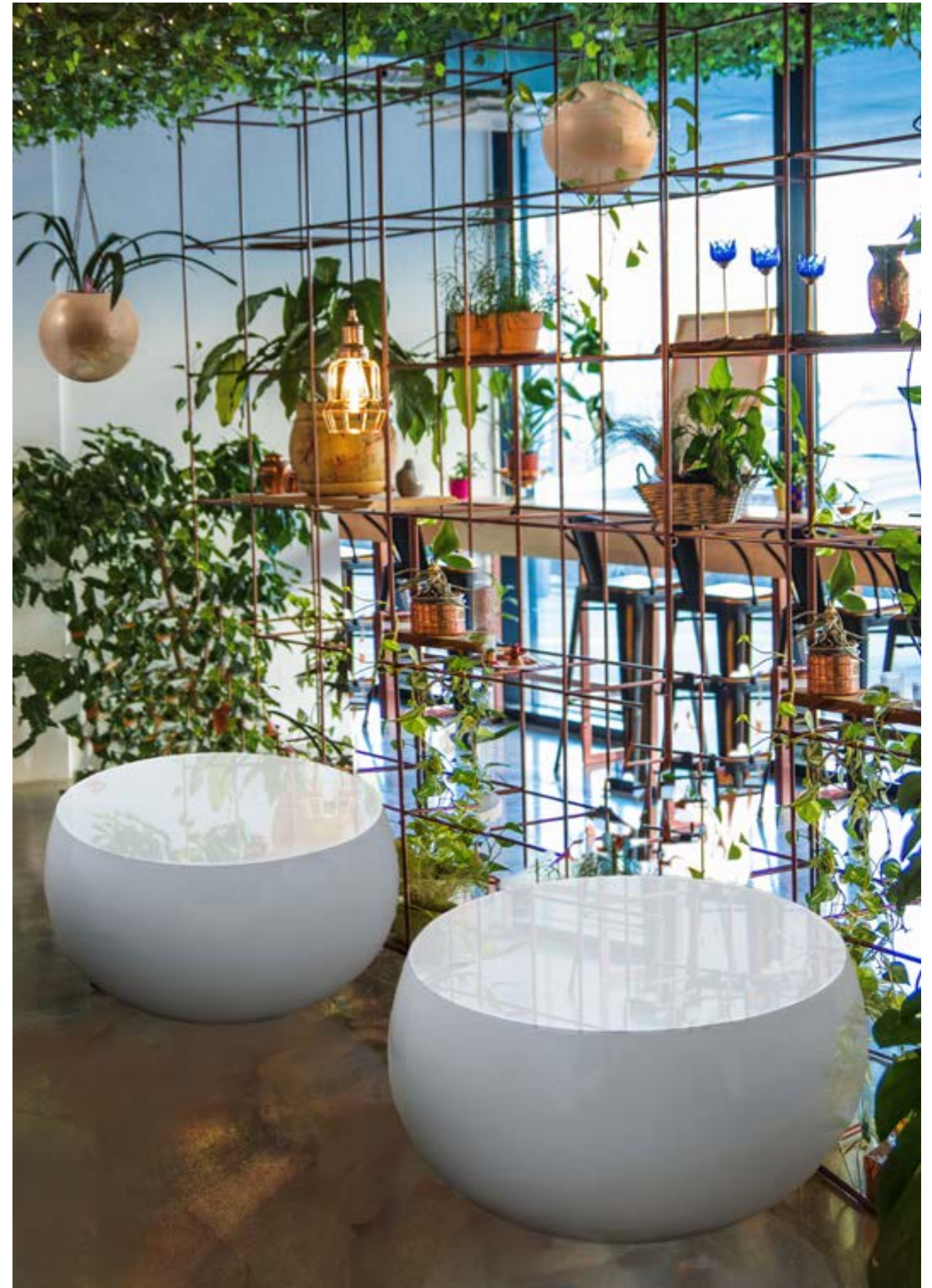

arrow bench

Bench seats and barriers are perfect for wayfinding, they can be colour coded and sign written as required. Optional holey design, combine with the Alphabet and Hearts ranges to communicate even more. Part of a larger range in the main brochure.

Colours + Finishes

BS4800 and RAL Classic: Full colour range in polished gloss, satin, matt and textured matt finishes.

Standard colours: All finishes.

Polished Metallics: All finishes.

Textured Metallics: All finishes.

Polished Pearlescents: All finishes.

Polished Stardust: All finishes.

Natural: All finishes.

Dapple: All finishes.

Premium Stone: All finishes.

See page 63 for all colour and finish options.

Code

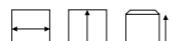

ARROWBE01 863 x 785 x 430mm

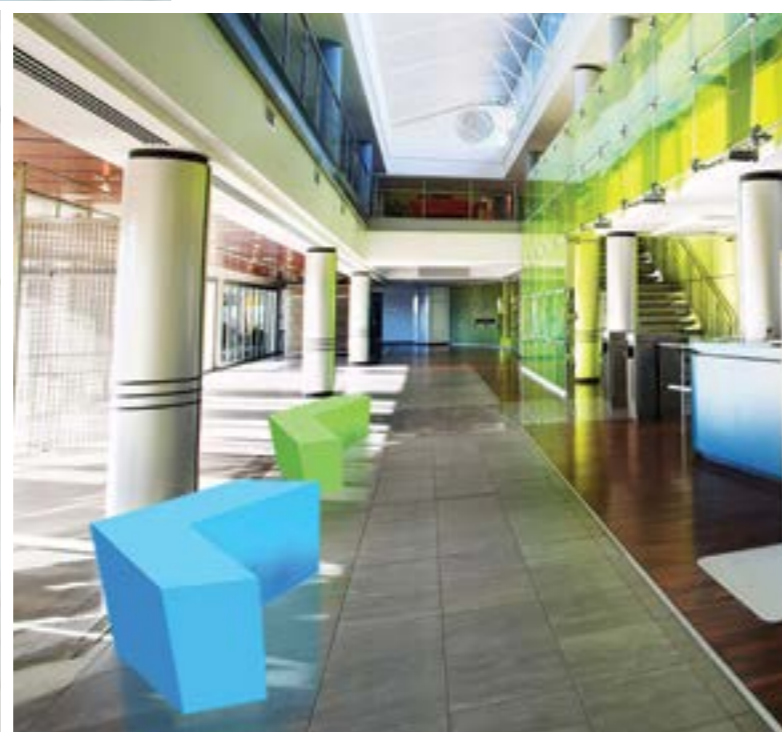
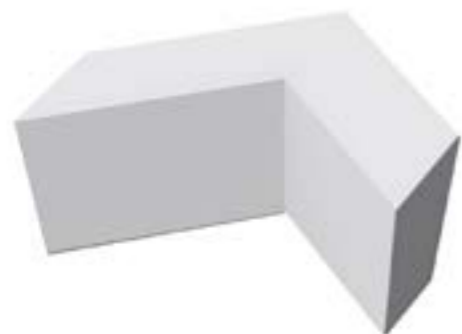

blob seating

Blob seating units feature a smooth fibreglass seat which can also be used as a table. The largest benches will seat 6 -7 people.

Colours + Finishes

BS4800 and RAL Classic: Full colour range in polished gloss, satin, matt and textured matt finishes.

Standard colours: All finishes.

Polished Metallics: All finishes.

Textured Metallics: All finishes.

Polished Pearlescents: All finishes.

Polished Stardust: All finishes.

Natural: All finishes.

Dapple: All finishes.

Premium Stone: All finishes.

See page 63 for all colour and finish options.

Code

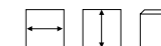

BLOBB01 915/437 x 780 x 450mm

BLOBB02 1100/495 x 918 x 450mm

BLOBB03 1544/693 x 1330 x 450mm

BLOBB04 714/360 x 603 x 450mm



curvy s bench

Curvy S bench, a natural organic addition to the Curvy family. Part of a larger range in the main brochure.

Colours + Finishes

BS4800 and RAL Classic: Full colour range in polished gloss, satin, matt and textured matt finishes.

Standard colours: All finishes.

Polished Metallics: All finishes.

Textured Metallics: All finishes.

Polished Pearlescents: All finishes.

Polished Stardust: All finishes.

Natural: All finishes.

Dapple: All finishes.

Premium Stone: All finishes.

See page 63 for all colour and finish options.

Code

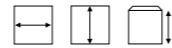

CURSB01 1200 x 450 x 450mm



easter island cube

Easter island cube, modular and sculptural like the rest of the collection, allows for increased planting and seating. Part of a larger range in the main brochure.

Colours + Finishes

BS4800 and RAL Classic: Full colour range in polished gloss, satin, matt and textured matt finishes.

Standard colours: All finishes.

Polished Metallics: All finishes.

Textured Metallics: All finishes.

Polished Pearlescents: All finishes.

Polished Stardust: All finishes.

Natural: All finishes.

Dapple: All finishes.

Premium Stone: All finishes.

See page 63 for all colour and finish options.

Supplied with topmost area in planter form and lower area as shelf or bench as standard. Please specify at time of ordering for variations from this layout

Code



EASILB03 900 x 600 x 900 650 x 510mm
with bench seat at 450mm ht

EASIL04 900 x 900 x 900 650 x 810mm
with shelf at 675mm ht

EASILB04 900 x 900 x 900 650 x 810mm
with bench seat at 450mm ht



EASILB04

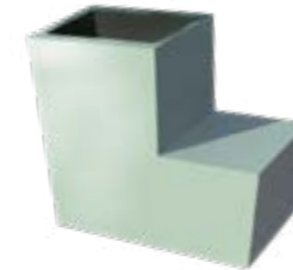

EASILB03



EASIL04

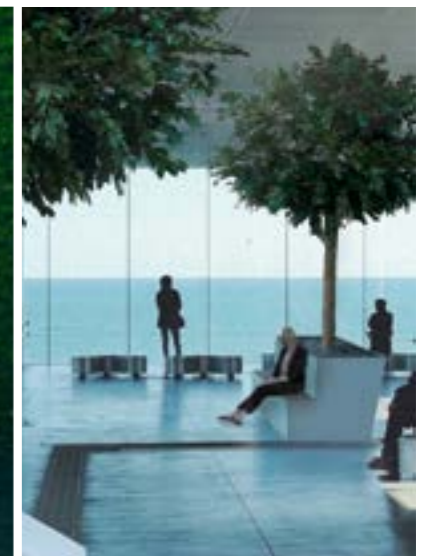

heart

The heart collection includes not only planters but stools, tables and benches. Say it with love.

Colours + Finishes

BS4800 and RAL Classic: Full colour range in polished gloss, satin and textured matt finishes.

Standard colours: All finishes.

Polished Metallics: All finishes.

Textured Metallics: All finishes.

Polished Pearlescents: All finishes.

Polished Stardust: All finishes.

Natural: All finishes.

Premium Stone: All finishes.

Code



HEARTST01 490 x 410 x 430mm

HEARTB01 1050 x 930 x 430mm

HEARTT01 490 x 410 x 720 mm



HEARTST01



HEARTB01

Bench can be supplied with or without a planting hole.

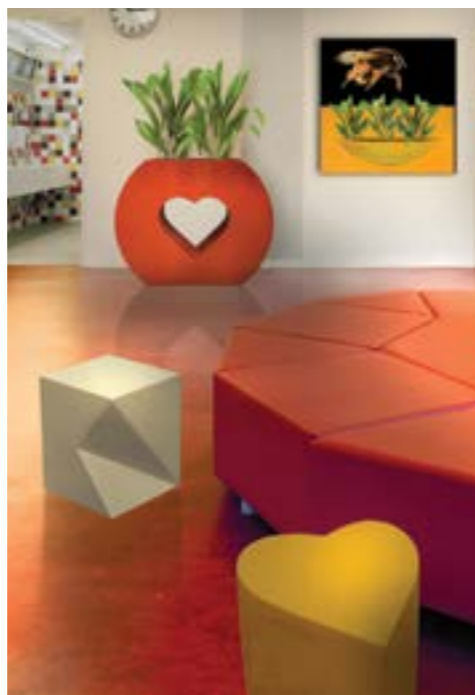

HEARTT01

pets

Pets are available as a modular range including : bench, planter, shelf, table, pet home and stool. Add accessories to personalise the range with a set of tops in cork, fabric or mirror.

Colours + Finishes

BS4800 and RAL Classic: Full colour range in polished gloss, satin, matt and textured matt finishes.

Standard colours: All finishes.

Polished Metallics: All finishes.

Textured Metallics: All finishes.

Polished Pearlescents: All finishes.

Polished Stardust: All finishes.

Natural: All finishes.

Premium Stone: All finishes.

See page 63 for all colour and finish options.

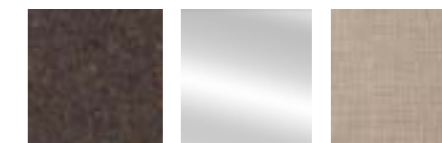

Cork Interior

Mirror Interior

Cushion Interior or exterior

Code

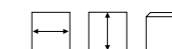

PETST01 450 x 450 x 450 stool / table

PETSP01 450 x 450 x 450 planter

PETSB02 900 x 450 x 450 bench / table

PETSP02 900 x 450 x 450 planter

table /square or circular side opening

PETSTC01 450 x 450 x 450 table /circular side opening

PETSTSQ01 450 x 450 x 450 table /square side opening

tall planter

PETSPSQ03 450 x 450 x 900 planter/square side opening

Accessories top : circular or square 34cm in cork, mirror, or cushion.

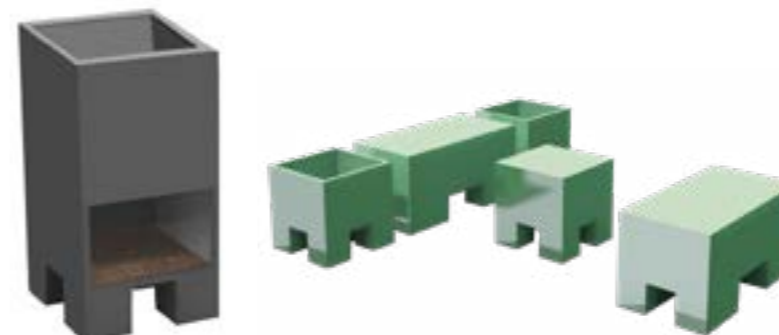
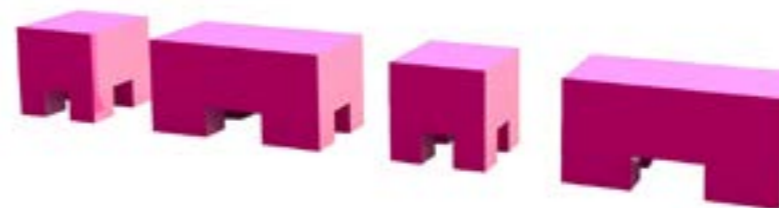

PETSPSQ03

planter square opening

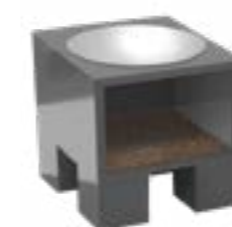

PETSTSQ01

table - mirror top square opening

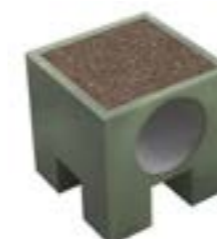

PETSTC01

table - cork top circular opening



PETST01

stool - cushion

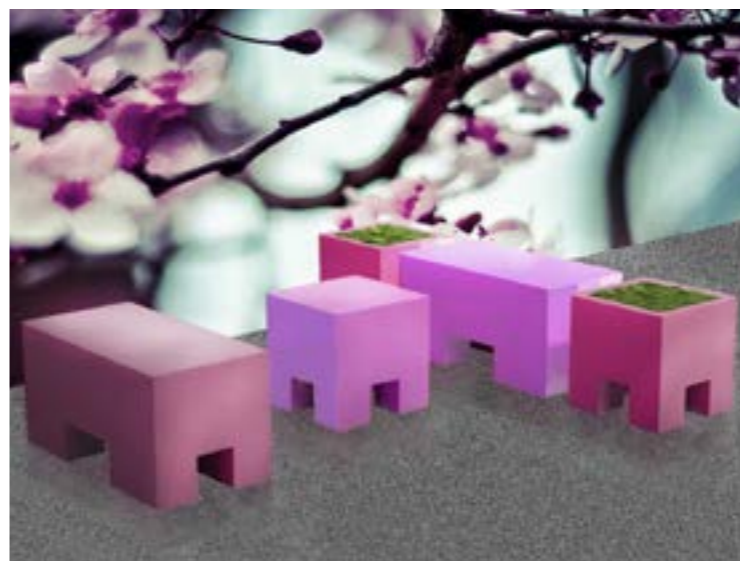

pentik

Pentik bench, table and stool to extend the original collection. Part of a larger range in the main brochure.

Colours + Finishes

BS4800 and RAL Classic: Full colour range in polished gloss, satin, matt and textured matt finishes.
Standard colours: All finishes.
Polished Metallics: All finishes.
Textured Metallics: All finishes.
Polished Pearlescents: All finishes.
Polished Stardust: All finishes.
Natural: All finishes.
Dapple: All finishes.
Premium Stone: All finishes.
 See page 63 for all colour and finish options.



PENTIKTA01



PENTIKST01

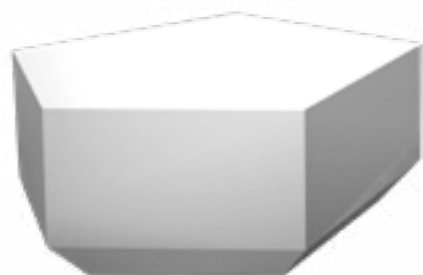

PENTIKBE01

Code

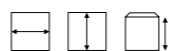

table	
PENTIKTA01	900 x 370 x 720mm
bench	
PENTIKBE01	1000 x 1000 x 450mm
stool	
PENTIKST01	430 x 430 x 460mm



PENTIKTA01



polybar

Polybar benches are available in two sizes, as a seat, planted or as a pond. Part of a larger range in the main brochure.

Colours + Finishes

BS4800 and RAL Classic: Full colour range in polished gloss, satin, matt and textured matt finishes.
Standard colours: All finishes.
Polished Metallics: All finishes.
Textured Metallics: All finishes.
Polished Pearlescents: All finishes.
Polished Stardust: All finishes.
Natural: All finishes.
Dapple: All finishes.
Premium Stone: All finishes.
 See page 63 for all colour and finish options.

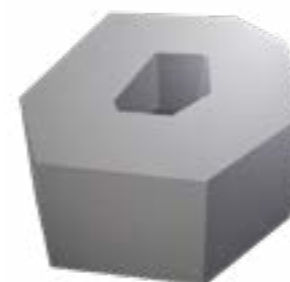

POLYBAR03



POLYBAR04

Code

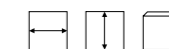

POLYBAR03	1210 x 960 x 450mm
POLYBAR04	1470 x 670 x 450mm

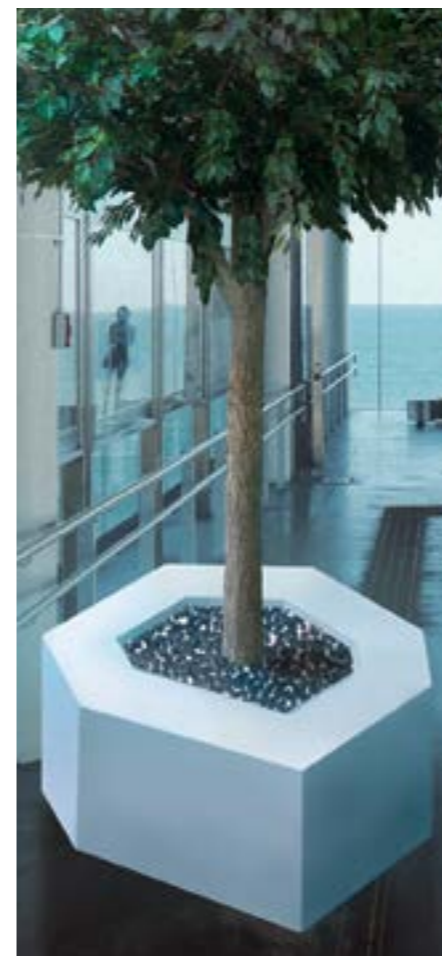

snapback seat

Created for RHS Chelsea Flower Show. These versatile planter seats are ideal for both interior and exterior use, seating up to 5 people.

Colours + Finishes

BS4800 and RAL Classic: Full colour range in polished gloss, satin, matt and textured matt finishes.
Standard colours: All finishes.
Polished Metallics: All finishes.
Textured Metallics: All finishes.
Polished Pearlescents: All finishes.
Polished Stardust: All finishes.
Natural: All finishes.
Dapple: All finishes.
Premium Stone: All finishes.
 See page 63 for all colour and finish options.



Code

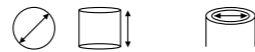

SNAPS01	2/3 pl	1290 x 450mm	690mm
SNAPS02	4/5 pl	1818 x 450mm	1191mm

Please note in order to take advantage of this seating capacity, snapback seats should be bolted to the floor for stability.



totem

Totem collection, available as planters, stools and tables, monochrome or bespoke highlighted triangles. Part of a larger range in the main brochure.

Colours + Finishes

BS4800 and RAL Classic: Full colour range in polished gloss, satin, matt and textured matt finishes.
Standard colours: All finishes.
Polished Metallics: All finishes.
Textured Metallics: All finishes.
Polished Pearlescents: All finishes.
Polished Stardust: All finishes.
Natural: All finishes.
Dapple: All finishes.
Premium Stone: All finishes.
 See page 63 for all colour and finish options.



Code

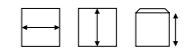

TOTEMST01	350 x 350 x 430mm
TOTEMT02	350 x 350 x 700mm





colours + finishes

Most Livinggreen planters are available in all the finishes detailed – but please check the product page for a full listing as the design of some units makes certain finishes impractical.

Most of our planters and furniture are available in all the finishes shown opposite. However, certain finishes such as rust/aged lead/copper blue/and terracotta are impractical for seating due to their nature in that there can be transfer of the finish to clothing.

Stone finishes can be used but their uneven surface maybe more uncomfortable than painted or textured finishes to sit upon.

For advice please call Sales on 0131 440 9804. Further details of the finishes can be found online :

www.livingreendesign.com

Please note we recommend Textured Premium stone and Natural finishes if planters are to be used outdoors. However all our finishes are suitable for exterior use – please specify this at the time of ordering.

Nous recommandons pour des usages extérieurs d'utiliser des finitions Texturées Pierre de Qualité ou Naturelles. Cependant toutes nos finitions conviennent pour l'usage à l'extérieur - spécifiez le lieu d'usage (intérieur ou extérieur) sur la commande.

BS4800 and RAL Classic: Over 300 colours available in highly polished gloss, satin, matt or textured matt finishes so you can achieve a perfect match to other furnishings.

BS4800 et RAL Classique: Plus de 300 couleurs disponibles avec plusieurs finitions : polie, satin ou mate texturée. Ainsi nos contenants permettent de trouver l'accord parfait avec l'esprit et l'aménagement du lieu.

Standard Colours: Specially selected colours that are usually held in stock and will meet most requirements. Available in highly polished gloss, satin, matt and textured matt.

Couleurs standard: Certaines couleurs sélectionnées parmi les gammes citées sont habituellement en stock et répondent à la plupart des exigences. Il s'agit des finitions suivantes : polie, satin et mate texturée.

Polished Metallics: The closest finishes to polished metal. Also available in satin sheen.

Métalliques polies: Finitions les plus semblant au métal poli.

Textured Metallics: Matt metal finishes with a rippled effect.

Métalliques texturées: Finitions en effet métal mat texturé.

Polished Pearlescents: Deep, almost 3D colours.

Perle polies: Finition créant un effet de profondeur.

Polished Stardust: Vibrant colour with a hint of silver sparkle. *Other colours on request – check availability before ordering.*

Stardust polies: Couleur scintillante incrustée de petites paillettes argentées. *Plusieurs couleurs sur demande - vérifiez la disponibilité.*

Dapple: Unique multicolour finishes adding further opportunities to personalise your planters. The finishes are coated with clear lacquer giving extra shine and a more resilient finish.

Moucheté: Finitions multicolores uniques rajoutant encore plus de possibilités de personnaliser vos pots. Les finitions sont recouvertes de vernis clair donnant un éclat supplémentaire et une finition plus résistante.

Natural: Unique finishes that exactly mimic natural materials. *Please note all these finishes have not only the look but also behave like the real material, weathering naturally if outdoors. However, the surfaces will mark clothes if brushed against so use indoors only in low footfall areas. Rust can be matt lacquered to avoid this problem on request.*

Naturel: Finitions uniques qui imitent exactement les vrais matériaux naturels. *De plus elles les ressemblent en aspect et en comportement. Par exemple les finitions rouille et cuivre bleu vieillissent naturellement en usage extérieur. Attention, ces surfaces pourront marquer les vêtements, il est recommandé pour leur usage en intérieur de ne pas les disposer à proximité des endroits passants. La rouille peut être mate laquée à la demande pour éviter cet inconvénient.*

Premium Stone: is a new finish range developed by Livinggreen Design to give the most realistic stone finish available on the market. *These finishes include a very high aggregate load and as such, also feel like real stone and are very hard wearing, resisting bumps and scratching. The 8 standard colours give a flavour of the colour range range, but there are over 70 variations available to order to better match the particular stone used on individual projects.*

Standard Colours - Couleurs standards



Polished Metallics - Métallique polie



Textured Metallics - Métalliques texturées



Polished Pearlescents - Perlé polie



Polished Stardust - Stardust polie



Dapple - Moucheté

Natural - Naturel

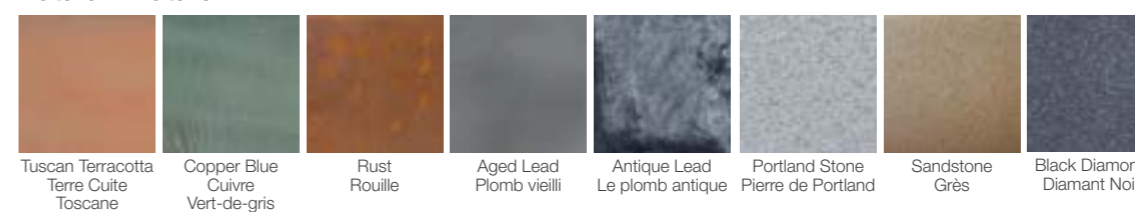

Premium Stone - Pierre de Qualité



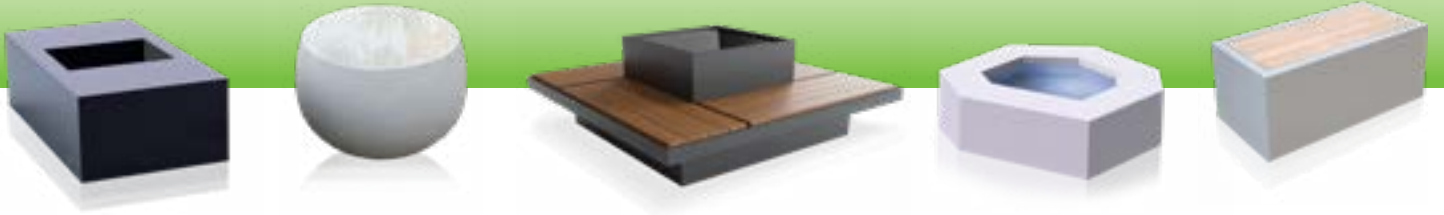

livinggreen
design

www.livingreendesign.com

Livingreen Design is a brand name of Livingreen Design Ltd t: +44(0)131 440 9804